

Warning

1. Read this document thoroughly before using TMB11, and keep it for ready reference.
2. Failure to follow the instructions closely can result in a loss of the thermostat's functions.
3. TMB11 is designed to mount the UP6/OP6/JP6 series thermostats on devices/components where the thermostats are used. Thermostats other than these series must not be mounted with TMB11. Do not use TMB11 for anything other than its intended use, as described in this document.
4. Upon completion of the thermostat mounting, verify the proper operation of the thermostat under the assumed conditions.
5. Overheating temperatures in an abnormal state must not exceed 190°C.

Note

- The enclosure height of the thermostat may decrease under a high-temperature environment, even if the thermostats are properly mounted in the way described earlier. However, the decrease will have no influence on the thermostat's performance. (The enclosure height may decrease up to approximately 0.1 mm when the mounted thermostats are subjected to an environment at 180°C for 24 h.)
- If you mount a thermostat in a way different from the correct way (See below: "Changes in the orientation and position"), or with insulation tubes, or if you tighten the screw after inserting the thermostat, check that those variations will have no influence on the thermostat's performance.

[Changes in the orientation and position]

The correct installation

(Recommended)

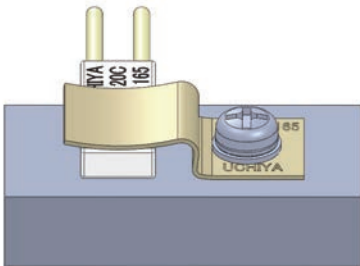

Different installations

(Check as necessary.)

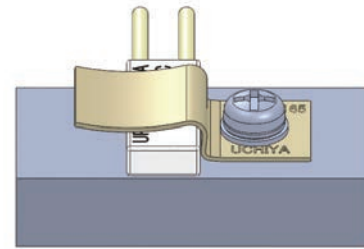
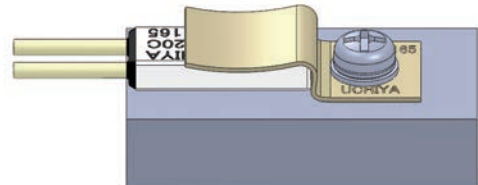
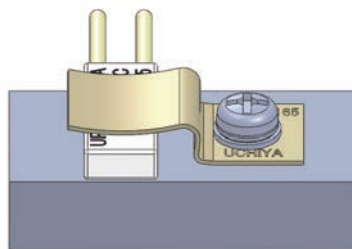

- Corrosion may occur between TMB11, your device/component and the mounting items (screw, split lock washer and flat washer), depending on environmental conditions. Please pay particular attention to your selection of materials for the mounting items to prevent possible corrosion from occurring. Testing for corrosion is advised.
- Loosening of the mounting items and the thermostat could occur due to vibration. Testing for loosening due to vibration is advised.